

LED1
LED-BLUE-5MM

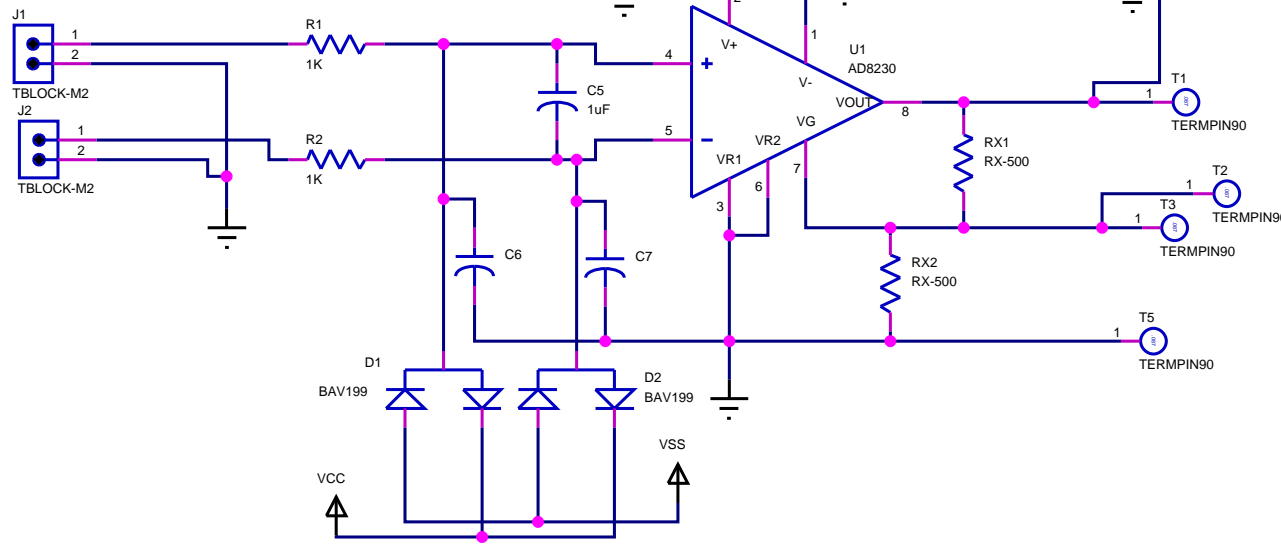
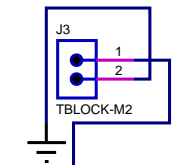
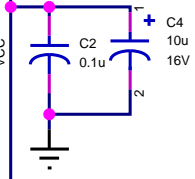
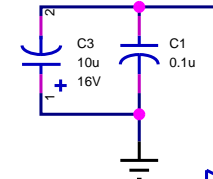
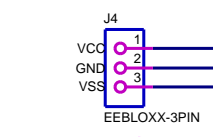
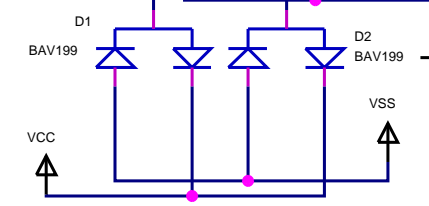
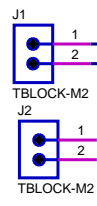

FILE NAME:	Instrumentation1.pdsprj	DATE:	4/21/2015
DESIGN TITLE:	Instrumentation1.pdsprj	PAGE:	1 of 1
PATH:	S:\Analog\AD8230\R2\Instrumentation1.pdsprj	TIME:	6:20:20 PM
BY:	@AUTHOR	REV:	@REV